

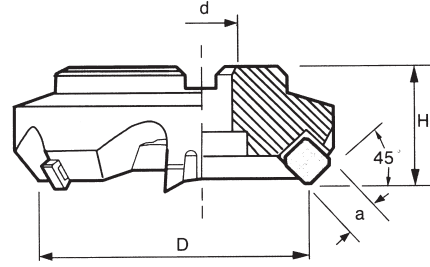

FACE Milling Cutter 45°

45°



ORDER NO.	D	dø		H	BLADE	WEIGHT(kg)		CODE NO.
		INCH	METRIC			INCH	METRIC	
SE545-3	80	25.4	27	50	5	2.1	2	6001-001
SE545-4	100	31.75	32	55	5	3.5	3.1	6001-002
SE545-5	125	38.1	40	60	6	5.1	5.3	6001-003
SE545-6	160	50.8	40	60	8	7.1	7	6001-004
SE545-8	200	47.625	60	60	10	10.4	9.5	6001-005
SE545-10	250	47.625	60	60	12	16.8		6001-006
SE545-12	300	47.625	60	60	14	27		6001-007

ORDER NO.	D	dø		H	BLADE	WEIGHT(kg)		CODE NO.
		INCH	METRIC			INCH	METRIC	
SE445-3	80	25.4	27	50	5	2.1	2	6001-020
SE445-4	100	31.75	32	55	5	3.2	3.1	6001-021
SE445-5	125	38.1	40	60	6	4.7	5.3	6001-022
SE445-6	160	50.8	40	60	8	7.3	7	6001-023
SE445-8	200	47.625	60	60	10	9.6	9.5	6001-024
SE445-10	250	47.625	60	60	12	16.7	17	6001-025
SE445-12	300	47.625	60	60	14	25.8		6001-026

PARTS

SCR-CL5/16	CL-S	SCR-ST-S4	ST-S	WRE-M4T

INSERT

445	545
SEKN-1203	SEKN-1504



FACE Milling Cutter 65°

65°

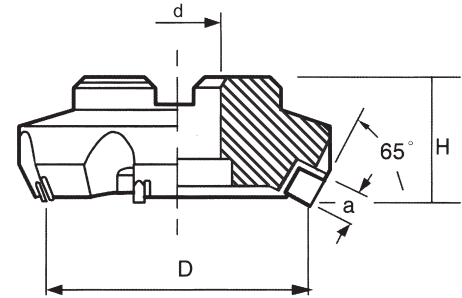
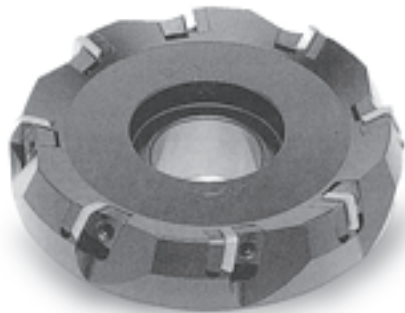

ORDER NO.	D	dø		H	BLADE	WEIGHT(kg)		CODE NO.
		INCH	METRIC			INCH	METRIC	
SP535-3	80	25.4	27	50	5	2.1	2.1	6001-040
SP535-4	100	31.75	32	55	5	3.3	3.3	6001-041
SP535-5	125	38.1	40	60	6	5.6	5.3	6001-042
SP535-6	160	50.8	40	60	8	7.4	7.2	6001-043
SP535-8	200	47.625	60	60	10	10.2	9.5	6001-044
SP535-10	250	47.625	60	60	12	17.5		6001-045
SP535-12	300	47.625	60	60	14			6001-046

ORDER NO.	D	dø		H	BLADE	WEIGHT(kg)		CODE NO.
		INCH	METRIC			INCH	METRIC	
SP435-3	80	25.4	27	50	5	2.1	2.3	6001-070
SP435-4	100	31.75	32	55	5	3.3	3.3	6001-071
SP435-5	125	38.1	40	60	6	5.5	5.4	6001-072
SP435-6	160	50.8	40	60	8	7.8	7.2	6001-073
SP435-8	200	47.625	60	60	10	10.1		6001-074
SP435-10	250	47.625	60	60	12	17.5		6001-075
SP435-12	300	47.625	60	60	14	26.8		6001-076

PARTS

SCR-CL5/16	CL-S	SCR-ST-S4	ST-S	WRN-M4T

INSERT

535	435
SPKN-1504	SPKN-1204



FACE Milling Cutter 75°

75°

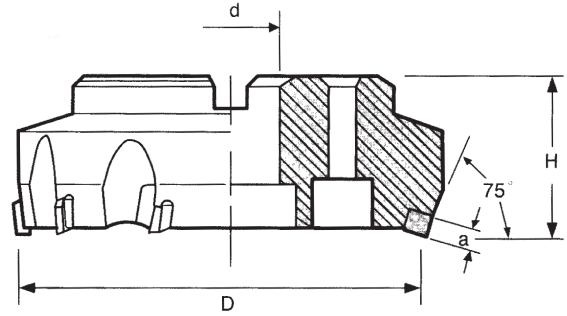
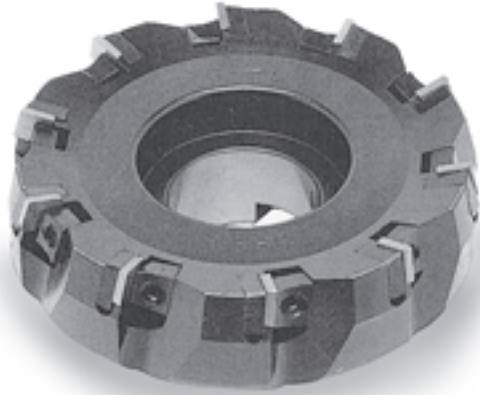

ORDER NO.	D	dφ		H	BLADE	WEIGHT(kg)		CODE NO.
		INCH	METRIC			INCH	METRIC	
FP-3	80	25.4	27	50	5	2	2	6001-090
FP-4	100	31.75	32	55	6	3.1	3.4	6001-091
FP-5	125	38.1	40	60	8	5.3	5.1	6001-092
FP-6	160	50.8	40	60	10	6.5	6.8	6001-093
FP-8	200	47.625	60	60	12	9.6	9.6	6001-094
FP-10	250	47.625	60	60	16	17.1		6001-095
FP-12	300	47.625	60	60	20	29.3		6001-096

INSERT	PARTS				
SPUN-120308					
SPKM-1203EDR					
	SCR-CL5/16	CL-S	SCR-ST-S4	ST-S	WRN-M4T



FACE Milling Cutter 90°

90°

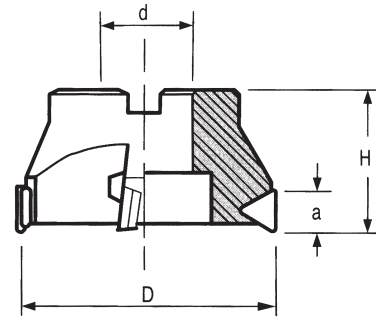
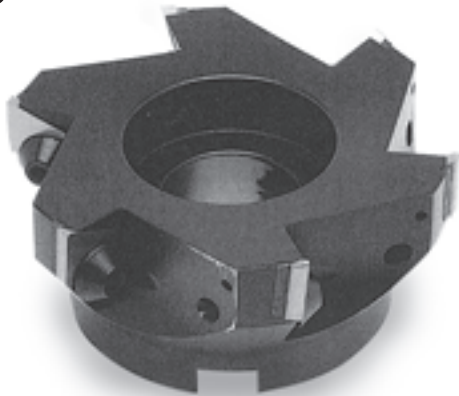



ORDER NO.	D	dφ		H	a	BLADE	WEIGHT(KG)	INSERT					CODE NO.	
		INCH	METRIC											
TP-63	63	25.4	27	50	22	3	1.1	TPMN 2204	ST-T	SCR-W5/16	WRN-M5L	SCR-ST-T4	6001-110	
TP-80	80	25.4	27	50	22	4	1.5		ST-T	SCR-W5/16	WRN-M5L	SCR-ST-T4	6001-111	
TP-100	100	31.75	32	55	22	5	2.2		ST-T	SCR-W5/16	WRN-M5L	SCR-ST-T4	6001-112	
TP-125	125	38.1	40	60	22	6	3.5		ST-T	SCR-W5/16	WRN-M5L	SCR-ST-T4	6001-113	
TP-160	160	50.8	40	60	22	7	5.9		TPKN 2204PPR	ST-T	SCR-W5/16	WRN-M5L	SCR-ST-T4	6001-114
TP-200	200	47.625	60	60	22	8	8.1			ST-T	SCR-W5/16	WRN-M5L	SCR-ST-T4	6001-115
TP-250	250	47.625	60	60	22	9	15.9			ST-T	SCR-W5/16	WRN-M5L	SCR-ST-T4	6001-116
TP-300	300	47.625	60	60	22	10	28			ST-T	SCR-W5/16	WRN-M5L	SCR-ST-T4	6001-117

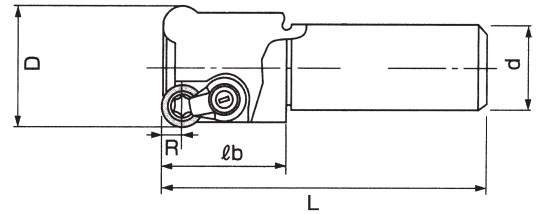
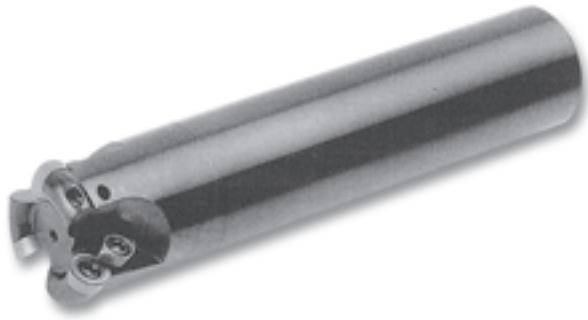

Round Insert End Mills





ORDER NO.	BLADE	D	L	d	lb	R	INSERT	CLAMP			CODE NO.
C20-4R20-150	2	20	150	20	50	4	RDMT0802	-	SCR-CRS3	T8	6002-001
C25-5R25-150	2	25	150	25	60	5	RDMT10T3	CL-5R	SCR-CRS4	T15	6002-002
C25-5R25-200	2	25	200	25	120	5	RDMT10T3	CL-5R	SCR-CRS4	T15	6002-003
C25-5R30-150	2	30	150	25	50	5	RDMT10T3	CL-5R	SCR-CRS4	T15	6002-004
C25-5R30-200	2	30	200	25	50	5	RDMT10T3	CL-5R	SCR-CRS4	T15	6002-005
C32-5R32-150	3	32	150	32	70	5	RDMT10T3	CL-5R	SCR-CRS4	T15	6002-006
C32-5R32-200	3	32	200	32	120	5	RDMT10T3	CL-5R	SCR-CRS4	T15	6002-007
C32-5R35X150	3	35	150	32	50	5	RDMT10T3	CL-5R	SCR-CRS4	T15	6002-008
C32-5R35X200	3	35	200	32	50	5	RDMT10T3	CL-5R	SCR-CRS4	T15	6002-009
C32-5R40X150	3	40	150	32	50	5	RDMT10T3	CL-5R	SCR-CRS4	T15	6002-010
C32-5R40X200	3	40	300	32	50	5	RDMT10T3	CL-5R	SCR-CRS4	T15	6002-011

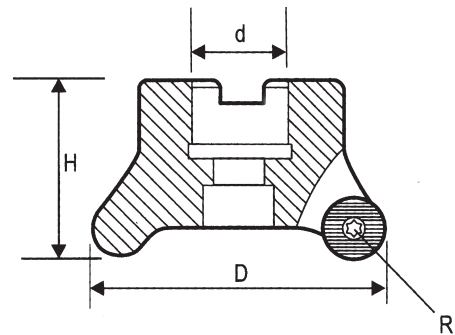
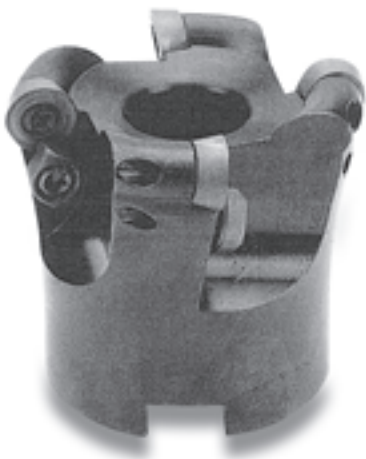

Round Insert Milling Cutter







ORDER NO.	D	d	d metrics	H	BLADE	R	INSERT		CLAMP		CODE NO.
RM-5R50	50	-	22	45	4	5	RDMT10T3	SCR-CRS4	CL-5R	T15	6001-130
RM-5R63	63	25.4	22	50	5	5	RDMT10T3	SCR-CRS4	CL-5R	T15	6001-131
RM-8R50	50	-	22	45	3	8	RDMT1604	SCR-CRS5	CL-8R	T20	6001-133
RM-8R63	63	25.4	22	50	3/4	8	RDMT1604	SCR-CRS5	CL-8R	T20	6001-134

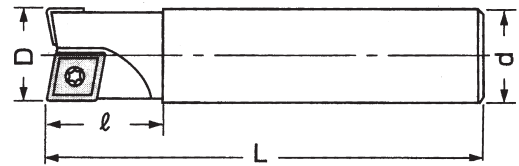
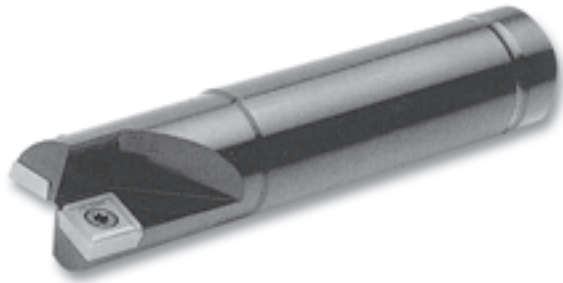

DRILLING & Milling Cutter





ORDER NO.	BLADE	D	L	d	l						CODE NO.
C16-DM16-120	2	16	120	16	30	CCMT060204	CPMT080204Z	SCR-CJU2.5	-	T8	6002-030
C16-DM16-175	2	16	175	16	40	CCMT060204	CPMT080204Z	SCR-CJU2.5	-	T8	6002-031
C20-DM20-130	2	20	130	20	30	CCMT060204	CPMT090204Z	SCR-CJU2.5	SCR-CJU3.5	T8.T15	6002-032
C20-DM20-185	2	20	185	20	50	CCMT060204	CPMT090204Z	SCR-CJU2.5	SCR-CJU3.5	T8.T15	6002-033
C25-DM25-130	2	25	130	25	40	CPMT090308	CPMT120308Z	SCR-CJU4	-	T15	6002-034
C25-DM25-220	2	25	220	25	70	CPMT090308	CPMT120308Z	SCR-CJU4	-	T15	6002-035
C32-DM32-170	2	32	170	32	50	CPMT120408	CPMT160408Z	SCR-CJU5	-	T20	6002-036
C32-DM32-250	2	32	250	32	80	CPMT120408	CPMT160408Z	SCR-CJU5	-	T20	6002-037
C32-DM40-170	2	40	170	32	50	CPMT160408Z	CPMT190408Z	SCR-CJU6	-	T20.T25	6002-038
C32-DM40-250	2	40	250	32	50	CPMT160408Z	CPMT190408Z	SCR-CJU6	-	T20.T25	6002-039

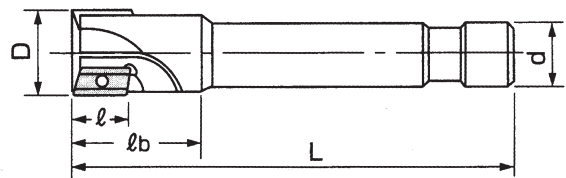
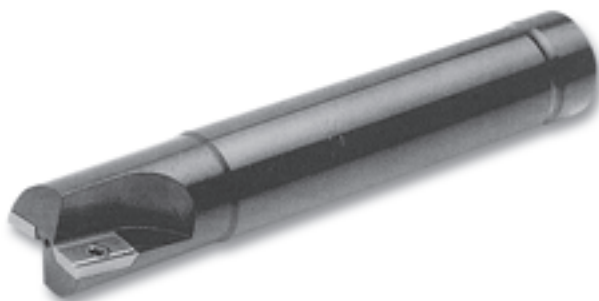

High Speed Shoulder Mills



ORDER NO.	BLADE	D	L	d	l	lb	HITACHI MITSUBISHI 			CODE NO.
C16-SS16-120H	1	16	120	16	12	30	APET120204	SCR-CEX3.5	T15	6002-060
C16-SS16-180H	1	16	180	16	12	30	APET120204	SCR-CEX3.5	T15	6002-061
C20-SS20-120H	2	20	120	20	12	30	APET120204	SCR-CEX3.5	T15	6002-062
C20-SS20-200H	2	20	200	20	15	30	ADET160304	SCR-CEX4	T15	6002-063
C25-SS25-130H	2	25	130	25	15	35	ADET160304	SCR-CEX4	T15	6002-064
C25-SS25-200H	2	25	200	25	15	35	ADET160304	SCR-CEX4	T15	6002-065
C32-SS32-150H	3	32	150	32	15	45	ADET160304	SCR-CEX4	T15	6002-066
C32-SS32-200H	3	32	200	32	15	45	ADET160304	SCR-CEX4	T15	6002-067
C32-SS40-170H	3	40	170	32	15	45	ADET160304	SCR-CEX4	T15	6002-068
C25-SS25-150M	2	25	150	25	14	35	APMT1604PDER	SCR-CAP4	T15	6002-069
C25-SS30-150M	2	30	150	25	14	45	APMT1604PDER	SCR-CAP4	T15	6002-070
C32-SS32-150M	2/3	32	150	32	14	45	APMT1604PDER	SCR-CAP4	T15	6002-080
C32-SS32-250M	3	32	250	32	-	60	APMT1604PDER	SCR-CAP4	T15	6002-081
C32-SS35-150M	3	35	150	32	14	45	APMT1604PDER	SCR-CAP4	T15	6002-082
C32-SS40-150M	4	40	150	32	14	45	APMT1604PDER	SCR-CAP4	T15	6002-083



Ball End Mills

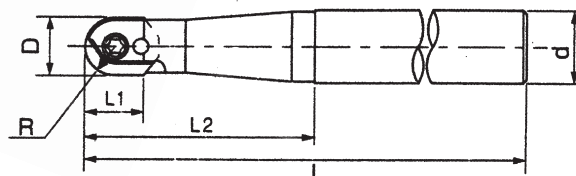

ORDER NO.	R	D	d	L	L ₁	L ₂	INSERT	SCREW	SCREW	WRENCH	WEIGHT (kg)	CODE NO.
C20-AR8-160	8	16	20	160	13	65	ZPFW160	SCR-AR8	SCR-CBP3.5	T15	0.5	6002-130
C25-AR10-180	10	20	25	180	17	80	ZPFW200	SCR-AR10	SCR-CBP5	T20		6002-131
C32-AR12.5-200	12.5	25	32	200	22	90	ZPFW250	SCR-AR12.5	SCR-CBP5	T20		6002-132
C32-AR15-220	15	30	32	220	27	100	ZPFW300	SCR-AR15	SCR-CBP6	T25		6002-133



Shoulder End Mills

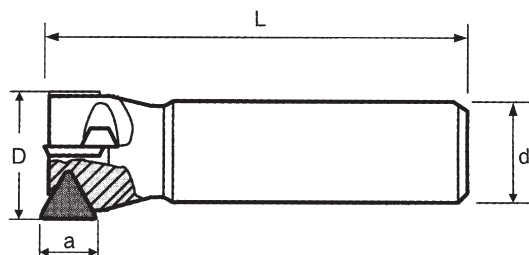
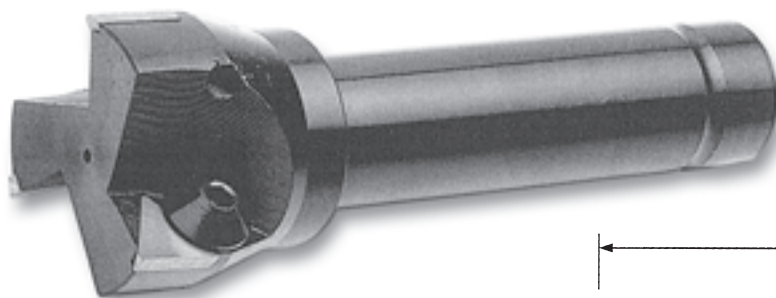

ORDER NO.	D	d	L	BLADE	INSERT			WEIGHT (kgs)	CODE NO.
SAE-20	20	20	110	2	TPMN110308	SCR-W3/16	WRN-M3L	0.3	6001-150
SAE-25	25	20	110	2	TPMN110308	SCR-W3/16	WRN-M3L	0.3	6001-151
SAE-30	30	20	130	2	TPMN160308	SCR-W1/4	WRN-M4L	0.3	6001-152
SAE-35	35	20	130	2	TPMN160308	SCR-W1/4	WRN-M4L	0.5	6001-153
SAE-40	40	20	130	3	TPMN160308	SCR-W1/4	WRN-M4L	0.7	6001-154
SAE-45	45	20	130	3	TPMN160308	SCR-W1/4	WRN-M4L	0.8	6001-155
SAE-50	50	20	130	3	TPMN160308	SCR-W1/4	WRN-M4L	0.9	6001-156
SAE-63	63	32	150	4	TPMN160308	SCR-W5/16	WRN-M4L	1.5	6001-157



CAP400R High Speed Shoulder Mills

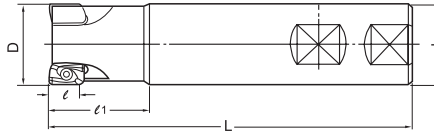

ORDER NO.	D	d	lb	l	L	BLADE				WEIGHT(kg)	CODE NO.
CAP400R-2525X150	25	25	35	14	150	2	APMT1604PDER	SCR-CAP4	T15	0.7	6003-040
CAP400R-2525X200	25	25	35	14	200	2	APMT1604PDER	SCR-CAP4	T15	0.9	6003-041
CAP400R-3025X150	30	25	45	14	150	2	APMT1604PDER	SCR-CAP4	T15	0.6	6003-042
CAP400R-3025X200	30	25	45	14	200	2	APMT1604PDER	SCR-CAP4	T15	0.9	6003-043
CAP400R-3232X150	32	32	45	14	150	3	APMT1604PDER	SCR-CAP4	T15	0.9	6003-044
CAP400R-3232X200	32	32	60	14	200	3	APMT1604PDER	SCR-CAP4	T15	1.3	6003-045
CAP400R-3532X150	35	32	45	14	150	3	APMT1604PDER	SCR-CAP4	T15	0.9	6003-046
CAP400R-3532X200	35	32	45	14	200	3	APMT1604PDER	SCR-CAP4	T15	1.3	6003-047
CAP400R-4032X150	40	32	45	14	150	4	APMT1604PDER	SCR-CAP4	T15	1.1	6003-048
CAP400R-5032X150	50	32	45	14	150	5	APMT1604PDER	SCR-CAP4	T15	1.5	6003-049



CRT Round Insert End Mills

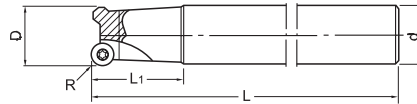

ORDER NO.	D	d	R	L	BLADE	INSERT				WEIGHT(kg)	CODE NO.
CRT-6R32X150	32	32	6	150	3	RPMT1204MO	SCR-W3/16S	SCR-CRT4		0.9	6003-051
CRT-6R32X200	32	32	6	200	3	RPMT1204MO	SCR-W3/16S	SCR-CRT4		1.3	6003-052
CRT-6R35X150	35	32	6	150	3	RPMT1204MO	SCR-W3/16S	SCR-CRT4		1.1	6003-053
CRT-6R35X200	35	32	6	200	3	RPMT1204MO	SCR-W3/16S	SCR-CRT4		1.3	6003-054



FACE End Mills

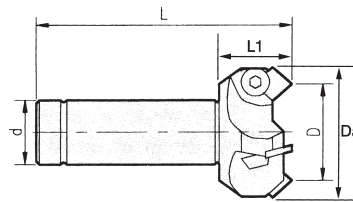

ORDER NO.	D	Da	d	L	L ₁	BLADE	INSERT				WEIGHT(kg)	CODE NO.
C-32-SE445-50	50	62	32	150	45	3	SEKN1203	SCR-W1/4L	WRN-M4T		1.25	6003-060
C-32-SE445-63	63	74	32	150	45	4	SEKN1203	SCR-W1/4L	WRN-M4T		1.3	6003-061



Shoulder Face Milling Cutter

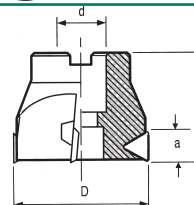

ORDER NO.	D	d METRIC	H	a	BLADE	INSERT				CODE NO.
TPS-50	50	□ 22	50	16	3	TPMN1603	SCR-W1/4	WRN-M4L		6003-065
TPS-63	63	25.4	50	16	4	TPMN1603	SCR-W1/4	WRN-M4L		6003-066



45° Chamfering End Mills



TC12

ORDER NO.	Cutter Dia.	Shank Dia.	Length	Capacity	Screw	Wrench	INSERT	CODE NO.
TC12	25 ^ø	12 ^ø	110	3 ^ø ~25 ^ø	M4	T15	TCMT16T304	6004-002



Cutting Holder

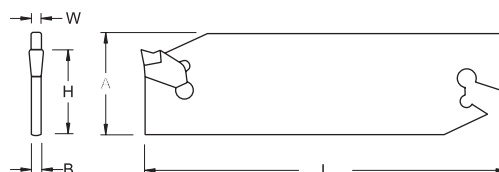
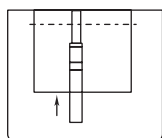

ORDER NO.	MAX.DIA	W	B	H	L	A	INSERT	Wrench	WEIGHT(kg)	CODE NO.
CGIH26-3	75	3	2.4	21	100	25.4	NGTN3	SL-1	0.65	6004-030
CGIH32-3	100	3	2.4	25	150	31.3			0.90	6004-031



Cutting Blocks

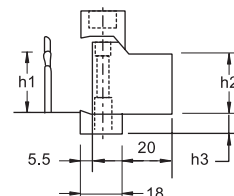
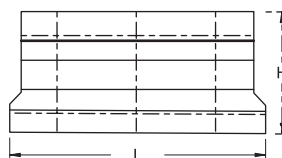
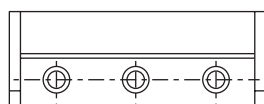

ORDER NO.	h ₁	h ₂	h ₃	H	L	Clamp	Screw	Wrench	Cutting Holders	WEIGHT(kg)	CODE NO.
SBU20-26	20	20	10	45	80	BCS15	BX0622	LH050	CGIH26-3	0.638	6004-060
SBU20-32	20	20	13.5	50	100	BCS20			CGIH32-3	0.808	6004-061
SBU25-32	25	25	8.5	50	110	BCS25			CGIH32-3	0.956	6004-062



Tool Holders

MCLN
95°

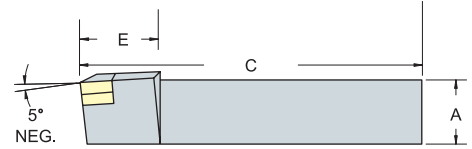
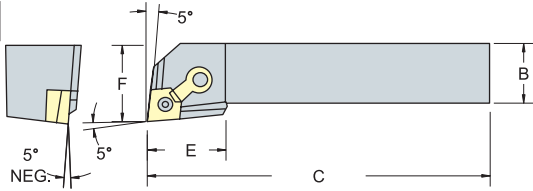

RIGHT HAND SHOWN LEFT HAND OPPOSITE

ORDER NO.		INSERT	DIMENSIONS					PARTS				WEIGHT(kg)		CODE NO.	
Righthand	Lefthand		A	B	C	E	F					Right	Left	Right	Left
MCLNR-1616H12	MCLNL-1616H12	CNMG 12 04 08	16	16	100	32	20	SMC-432	LCS-617	CP50-22	CS70-22	0.25	0.25	6005-001	6005-101
MCLNR-2020K12	MCLNL-2020K12	CNMG 12 04 08	20	20	125	32	25	SMC-432	LCS-617	CP50-22	CS70-22	0.45	0.45	6005-002	6005-102
MCLNR-2525M12	MCLNL-2525M12	CNMG 12 04 08	25	25	150	32	32	SMC-432	LCS-617	CP50-22	CS70-22	0.80	0.80	6005-003	6005-103
MCLNR-3225P12	MCLNL-3225P12	CNMG 12 04 08	32	25	170	32	32	SMC-432	LCS-617	CP50-22	CS70-22	1.20	1.20	6005-004	6005-104

MCRN
75°

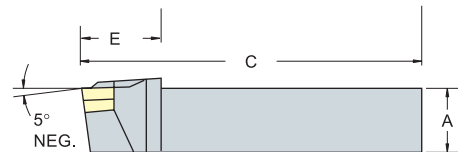
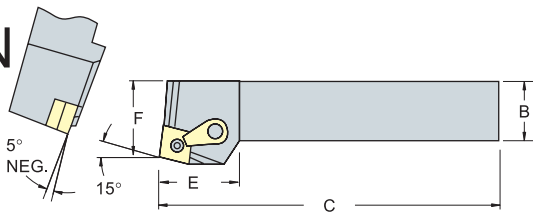

RIGHT HAND SHOWN LEFT HAND OPPOSITE

ORDER NO.		INSERT	DIMENSIONS					PARTS				WEIGHT(kg)		CODE NO.	
Righthand	Lefthand		A	B	C	E	F					Right	Left	Right	Left
MCRNR-2020K12	MCRNL-2020K12	CNMG 12 04 08	20	20	125	32	25	SMC-432	LCS-617	CP50-22	CS70-22	0.45	0.45	6005-030	6005-130
MCRNR-2525M12	MCRNL-2525M12	CNMG 12 04 08	25	25	150	32	32	SMC-432	LCS-617	CP50-22	CS70-22	0.80	0.80	6005-031	6005-131
MCRNR-3225P12	-	CNMG 12 04 08	32	25	170	32	32	SMC-432	LCS-617	CP50-22	CS70-22	1.20	-	6005-032	-

MTJN
93°

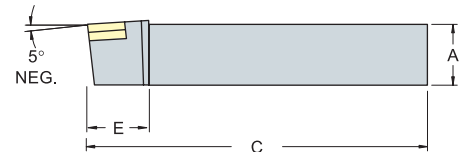
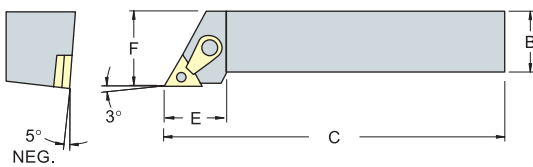

RIGHT HAND SHOWN LEFT HAND OPPOSITE

ORDER NO.		INSERT	DIMENSIONS					PARTS				WEIGHT(kg)		CODE NO.	
Righthand	Lefthand		A	B	C	E	F					Right	Left	Right	Left
MTJNR-2020K16	MTJNL-2020K16	TNMG 16 04 08	20	20	125	32	25	SMT-322	LCS-513	CP50-22	CS70-22	0.45	0.45	6005-060	6005-160
MTJNR-2525M16	MTJNL-2525M16	TNMG 16 04 08	25	25	150	32	32	SMT-322	LCS-513	CP50-22	CS70-22	0.80	0.80	6005-061	6005-161

MTEN
60°

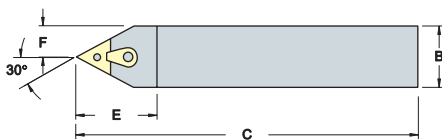

NEUTRAL HAND

ORDER NO.		INSERT	DIMENSIONS					PARTS				WEIGHT(kg)		CODE NO.	
Righthand			A	B	C	E	F					Right	Left	Right	Left
MTENN-2020K16		TNMG 16 04 08	20	20	125	32	10.46	SMT-322	LCS-513	CP50-22	CS70-22	0.45		6005-090	
MTENN-2525M16		TNMG 16 04 08	25	25	150	32	12.95	SMT-322	LCS-513	CS50-22	CS70-22	0.80		6005-091	



Tool Holders

MSD
45°

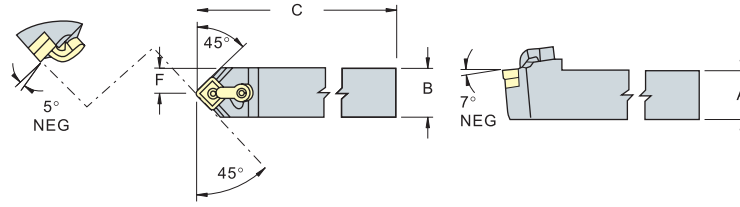

ORDER NO.	INSERT	DIMENSIONS				PARTS				WEIGHT(kg)	CODE NO.
Righthand		A	B	C	F					Right	Right
MSDNN-2020K12	SN□□1204□□	20	20	125	10.3	SMS-432	LCS-617	CP50-22	CS70-22	0.45	6005-120
MSDNN-2525M12	SN□□1204□□	25	25	150	12.8	SMS-432	LCS-617	CP50-22	CS70-22	0.80	6005-121
MSDNN-3225P12	SN□□1204□□	32	25	170	12.8	SMS-432	LCS-617	CP50-22	CS70-22	1.20	6005-122

MVVN
72° 30'

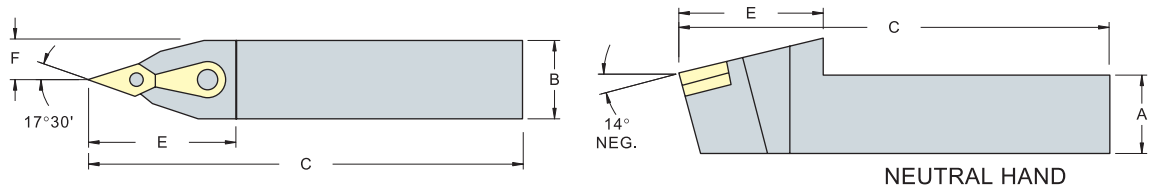

ORDER NO.	INSERT	DIMENSIONS					PARTS				WEIGHT(kg)	CODE NO.
Righthand		A	B	C	E	F					Right	Right
MVVNN-2020K 16K	VNMG 16 04 08	20	20	125	42	10.57	SMV-322	LCS-513	CP50-25	CS70-22	0.45	6005-150
MVVNN-2525M 16K	VNMG 16 04 08	25	25	150	42	13.06	SMV-322	LCS-513	CP50-25	CS70-22	0.80	6005-151
MVVNN-3225P 16K	VNMG 16 04 08	32	25	170	42	13.06	SMV-322	LCS-513	CP50-25	CS70-22	1.20	6005-152

MDJN
93°

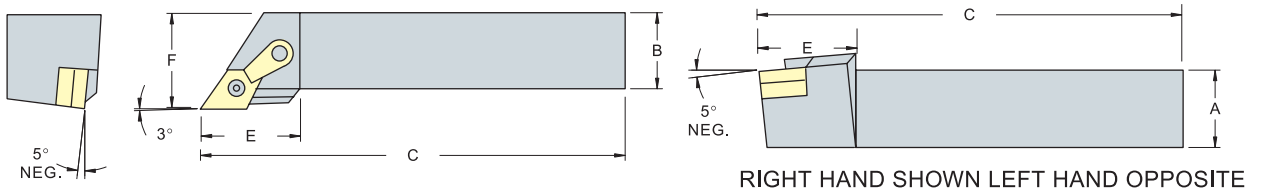

ORDER NO.	INSERT	DIMENSIONS					PARTS				WEIGHT(kg)		CODE NO.		
Righthand	Lefthand		A	B	C	E	F					Right	Left	Right	Left
MDJNR-2020K15	MDJNL-2020K15	DNMG 15 04 08	20	20	125	36	25	SMD-463	LCS-619	CP50-24	CS70-22	0.45	0.45	6005-180	6005-280
MDJNR-2525M15	MDJNL-2525M15	DNMG 15 04 08	25	25	150	36	32	SMD-463	LCS-619	CP50-24	CS70-22	0.80	0.80	6005-181	6005-281
MDJNR-3225P15	MDJNL-3225P15	DNMG 15 04 08	32	25	170	36	32	SMD-463	LCS-619	CP50-24	CS70-22	1.20	1.20	6005-182	6005-282

MVJN
93°

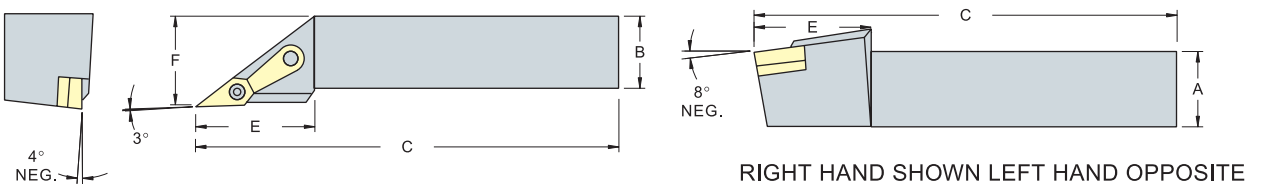

ORDER NO.	INSERT	DIMENSIONS					PARTS				WEIGHT(kg)		CODE NO.		
Righthand	Lefthand		A	B	C	E	F					Right	Left	Right	Left
MVJNR-2020K16	MVJNL-2020K16	VNMG 16 04 08	20	20	125	37	25	SMV-322	LCS-513	CP50-25	CS70-22	0.45	0.45	6005-210	6005-310
MVJNR-2525M16	MVJNL-2525M16	VNMG 16 04 08	25	25	150	37	32	SMV-322	LCS-513	CP50-25	CS70-22	0.80	0.80	6005-211	6005-311
MVJNR-3225P16	MVJNL-3225P16	VNMG 16 04 08	32	25	170	37	32	SMV-322	LCS-513	CP50-25	CS70-22	1.20	1.20	6005-212	6005-312



Tool Holders

WTJN

93°

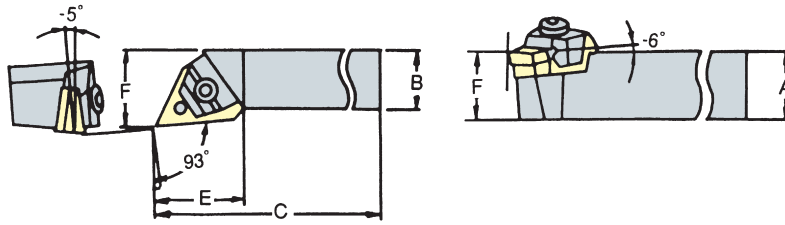

ORDER NO.		INSERT	DIMENSIONS					PARTS					WEIGHT(kg)		CODE NO.		
Righthand	Lefthand		A	B	C	E	F							Right	Left	Right	Left
WTJNR-2020K16	WTJNL-2020K16	TNMG 16 04 08	20	20	125	32	25	SMT-323	LCS-415	LCS-4B	MMW-30	CS70-24	LW030	0.45	0.45	6005-240	6005-340
WTJNR-2525M16	WTJNL-2525M16	TNMG 16 04 08	25	25	150	32	32	SMT-323	LCS-420	LCS-4B	MMW-30	CS70-24	LW030	0.80	0.80	6005-241	6005-341

WTEN

60°

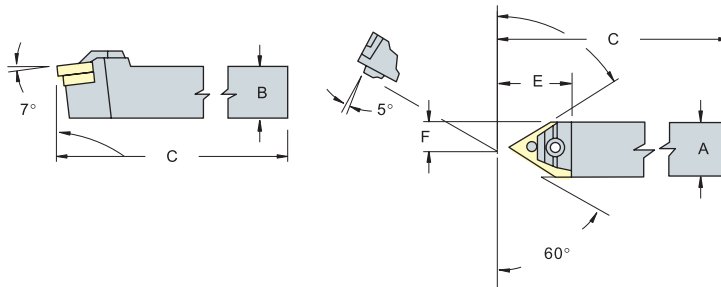

ORDER NO.		INSERT	DIMENSIONS					PARTS					WEIGHT(kg)		CODE NO.		
Righthand			A	B	C	E	F							Right	Right		
WTENN-2020K16		TNMG 16 04 08	20	20	125	32	10	SMT-323	LCS-415	LCS-4B	MMW-30	CS70-24	LW030	0.45	6005-270		
WTENN-2525M16		TNMG 16 04 08	25	25	150	38	12.5	SMT-323	LCS-420	LCS-4B	MMW-30	CS70-24	LW030	0.80	6005-271		

WTXN

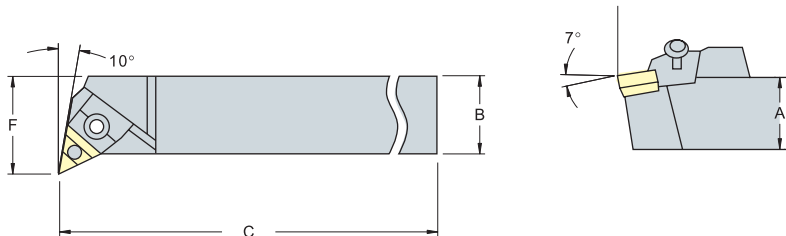

ORDER NO.		INSERT	DIMENSIONS					PARTS					WEIGHT(kg)		CODE NO.		
Righthand	Lefthand		A	B	C	E	F							Right	Left	Right	Left
WTXNR-2020K16	WTXNL-2020K16	TNMG 16 04 08	20	20	125	32	25	SMT-323	LCS-415	LCS-4B	MMW-30	CS70-24	LW030	0.45	0.45	6005-300	6005-400
WTXNR-2525M16	WTXNL-2525M16	TNMG 16 04 08	25	25	150	32	32	SMT-323	LCS-420	LCS-4B	MMW-30	CS70-24	LW030	0.80	0.80	6005-301	6005-401

WWLN

95°

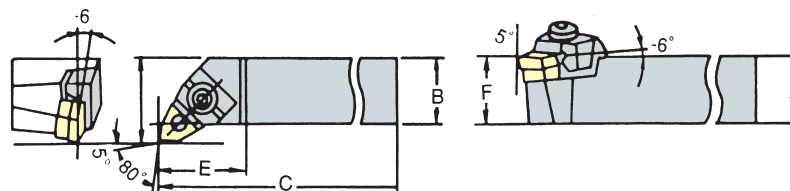

ORDER NO.		INSERT	DIMENSIONS					PARTS					WEIGHT(kg)		CODE NO.		
Righthand	Lefthand		A	B	C	E	F							Right	Left	Right	Left
WWLNR-2020K08	WWLNL-2020K08	WNMG 08 04 08	20	20	125	32	25	SMW-433	LCS-516	LCS-5B	MMW-40	CS70-25	LW040 & LW030	0.45	0.45	6005-330	6005-430
WTNLR-2525M08	WWLNL-2525M08	WNMG 08 04 08	25	25	150	32	32	SMW-433	LCS-520	LCS-5B	MMW-40	CS70-25	LW040 & LW030	0.80	0.80	6005-331	6005-431
WWLNR-3225P08	WWLNL-3225P08	WNMG 08 04 08	32	25	170	32	32	SMW-433	LCS-520	LCS-5B	MMW-40	CS70-25	LW040 & LW030	1.20	1.20	6005-332	6005-432



Tool Holders

SCLC

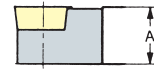
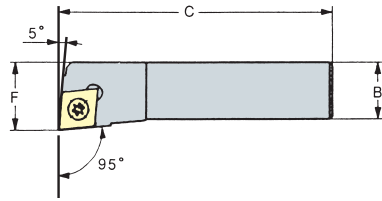

ORDER NO.		INSERT	DIMENSIONS				PARTS		WEIGHT(kg)		CODE NO.	
Righthand	Lefthand		A	B	C	F			Right	Left	Right	Left
SCLCR-0808H06	SCLCL-0808H06	CC□□0602□□	8	8	100	10	CS2560	FT-7	0.06	0.06	6005-360	6005-460
SCLCR-1010H06	SCLCL-1010H06	CC□□0602□□	10	10	100	12	CS2560	FT-7	0.08	0.08	6005-361	6005-461
SCLCR-1212H09	SCLCL-1212H09	CC□□09T3□□	12	12	100	16	CS3590	FT-15	0.12	0.12	6005-362	6005-462
SCLCR-1616H09	SCLCL-1616H09	CC□□09T3□□	16	16	100	20	CS3590	FT-15	0.21	0.21	6005-363	6005-463

SDJC

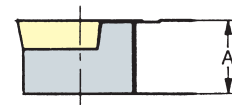
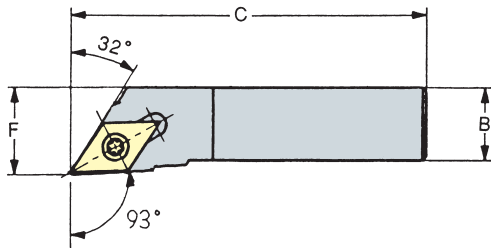

ORDER NO.		INSERT	DIMENSIONS				PARTS		WEIGHT(kg)		CODE NO.	
Righthand	Lefthand		A	B	C	F			Right	Left	Right	Left
SDJCR-0808H07	SDJCL-0808H07	DC□□0702□□	8	8	100	10	CS2560	FT-7	0.06	0.06	6005-390	6005-490
SDJCR-1010H07	SDJCL-1010H07	DC□□0702□□	10	10	100	12	CS2560	FT-7	0.08	0.08	6005-391	6005-491
SDJCR-1212H11	SDJCL-1212H11	DC□□11T3□□	12	12	100	16	CS4090	FT-15	0.12	0.12	6005-392	6005-492
SDJCR-1616H11	SDJCL-1616H11	DC□□11T3□□	16	16	100	20	CS4090	FT-15	0.21	0.21	6005-393	6005-493

SVJC

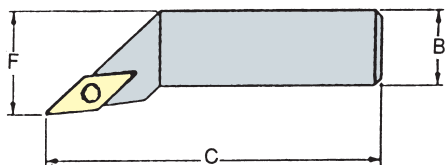

ORDER NO.		INSERT	DIMENSIONS				PARTS				WEIGHT(kg)		CODE NO.	
Righthand	Lefthand		A	B	C	F					Right	Left	Right	Left
SVJCR-1010H11	SVJCL-1010H11	VC□□1103□□	10	10	100	10.5	-	-	CS2560	FT-7	0.08	0.08	6005-420	6005-520
SVJCR-1212H11	SVJCL-1212H11	VC□□1103□□	12	12	100	12.5	-	-	CS2560	FT-7	0.12	0.12	6005-421	6005-521
SVJCR-1616H11	SVJCL-1616H11	VC□□1103□□	16	16	100	16.5	-	-	CS2560	FT-7	0.21	0.21	6005-422	6005-522
SVJCR-2020K16	SVJCL-2020K16	VC□□1604□□	20	20	125	25	SMV-322	SN535	CS3511	FT-15	0.40	0.40	6005-423	6005-523
SVJCR-2525M16	SVJCL-2525M16	VC□□1604□□	25	25	150	32	SMV-322	SN535	CS3511	FT-15	0.72	0.72	6005-424	6005-524

SVVC

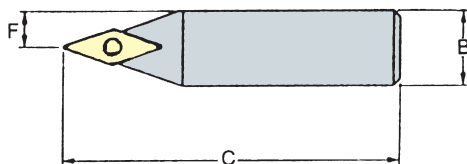

ORDER NO.		INSERT	DIMENSIONS				PARTS				WEIGHT(kg)		CODE NO.	
			A	B	C	F					Right	Left		
	SVVCN-1010H11	VC□□1103□□	10	10	100	5	-	-	CS2560	FT-7	0.08	0.08		6005-450
	SVVCN-1212H11	VC□□1103□□	12	12	100	6	-	-	CS2560	FT-7	0.12	0.12		6005-451
	SVVCN-1616H11	VC□□1103□□	16	16	100	8	-	-	CS2560	FT-7	0.21	0.21		6005-452
	SVVCN-2020K16	VC□□1604□□	20	20	125	10	SMV-322	SN535	CS3511	FT-15	0.40	0.40		6005-453
	SVVCN-2525M16	VC□□1604□□	25	25	150	12.5	SMV-322	SN535	CS3511	FT-15	0.72	0.72		6005-454



Boring Bars

MWLN 95°

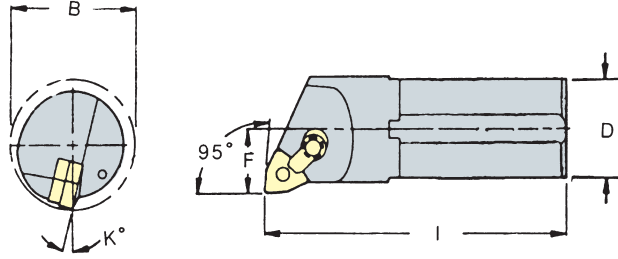

ORDER NO.		INSERT	DIMENSIONS					PARTS				WEIGHT(kg)		CODE NO.	
Righthand	Lefthand		D	F	I	B	K°					Right	Left	Right	Left
S20R-MWLN08	S20R-MWLN08	WNMG 08 04	20	13	200	25	17°	-	LCS-511	CP50-26	CS70-21	0.50	0.50	6005-480	6005-580
S25R-MWLN08	S25R-MWLN08	WNMG 08 04	25	17	200	32	14°	-	LCS-511	CP50-26	CS70-21	0.95	0.95	6005-481	6005-581
S32S-MWLN08	S32S-MWLN08	WNMG 08 04	32	22	250	40	14°	SMW-422	LCS-614	CP50-22	CS70-22	1.60	1.60	6005-482	6005-582
S40T-MWLN08	S40T-MWLN08	WNMG 08 04	40	27	300	50	12°	SMW-422	LCS-614	CP50-22	CS70-22	2.90	2.90	6005-483	6005-583
S50U-MWLN08	S50U-MWLN08	WNMG 08 04	50	35	350	63	12°	SMW-422	LCS-614	CP50-22	CS70-22	5.90	5.90	6005-484	6005-584

MCLN 95°

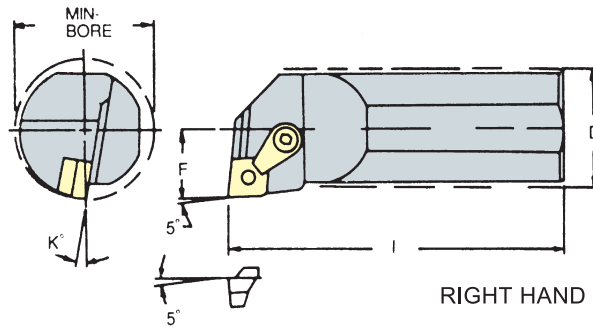

ORDER NO.		INSERT	DIMENSIONS					PARTS				WEIGHT(kg)		CODE NO.	
Righthand	Lefthand		D	F	I	B	K°					Right	Left	Right	Left
S20R-MCLNR12	S20R-MCLNL12	CNMG 12 04 08	20	13	200	25	17°	-	LCS-511	CP50-26	CS70-21	0.50	0.50	6005-510	6005-610
S25R-MCLNR12	S25R-MCLNL12	CNMG 12 04 08	25	17	200	32	14°	-	LCS-511	CP50-26	CS70-21	0.95	0.95	6005-511	6005-611
S32S-MCLNR12	S32S-MCLNL12	CNMG 12 04 08	32	22	250	40	14°	SMC-432	LCS-617	CP50-22	CS70-22	1.60	1.60	6005-512	6005-612
S40T-MCLNR12	S40T-MCLNL12	CNMG 12 04 08	40	27	300	50	12°	SMC-432	LCS-617	CP50-22	CS70-22	2.90	2.90	6005-513	6005-613
S50U-MCLNR12	S50U-MCLNL12	CNMG 12 04 08	50	35	350	63	12°	SMC-432	LCS-617	CP50-22	CS70-22	5.90	5.90	6005-514	6005-614

MDUN 93°

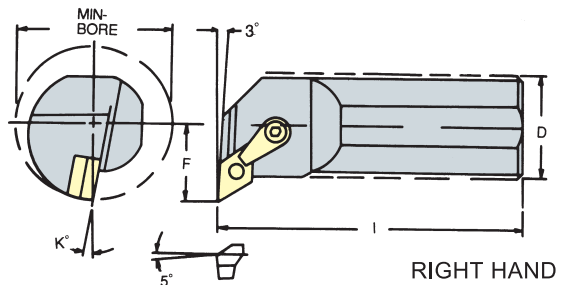

ORDER NO.		INSERT	DIMENSIONS					PARTS				WEIGHT(kg)		CODE NO.	
Righthand	Lefthand		D	F	I	B	K°					Right	Left	Right	Left
S25R-MDUNR15	S25R-MDUNL15	DNMG 15 04 08	25	17	200	32	12°	SMD-443	LCS-617	CS50-24	CS70-22	0.95	0.95	6005-540	6005-640
S32S-MDUNR15	S32S-MDUNL15	DNMG 15 04 08	32	22	250	40	10°	SMD-443	LCS-617	CS50-24	CS70-22	1.60	1.60	6005-541	6005-641
S40T-MDUNR15	S40T-MDUNL15	DNMG 15 04 08	40	27	300	50	10°	SMD-443	LCS-617	CS50-24	CS70-22	2.90	2.90	6005-542	6005-642
S50U-MDUNR15	S50U-MDUNL15	DNMG 15 04 08	50	35	350	63	10°	SMD-443	LCS-617	CS50-24	CS70-22	5.90	5.90	6005-543	6005-643



Boring Bars

SMALL SIZE

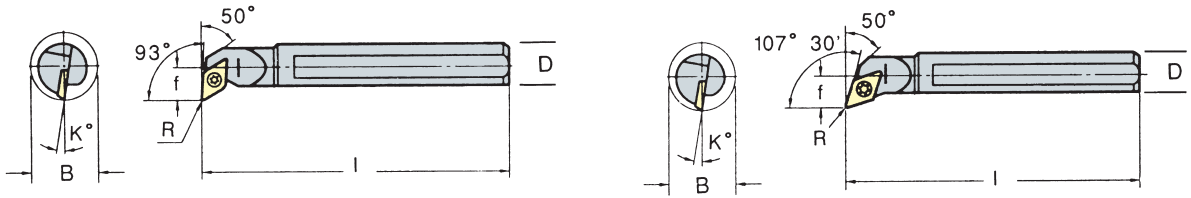

ORDER NO.		DIMENSIONS					INSERT	PARTS		WEIGHT(kg)		CODE NO.	
Righthand	Lefthand	D	F	I	B	K°				Right	Left	Right	Left
S10K-SDUCR07	S10K-SDUCL07	10	7	125	13	10°	DCMT 0702□□	CS2560	FT-7	0.15	0.15	6005-570	6005-670
S12M-SDUCR07	S12M-SDUCL07	12	9	150	16	8°				0.18	0.18	6005-571	6005-671
S16Q-SDUCR07	S16Q-SDUCL07	16	11	180	20	6°				0.28	0.28	6005-572	6005-672
S20R-SDUCR11	S20R-SDUCL11	20	13	200	25	8°	DCMT 11T3□□	CS4010	FT-15	0.45	0.45	6005-573	6005-673
S25R-SDUCR11	S25R-SDUCL11	25	17	200	32	4°				0.60	0.60	6005-574	6005-674
S10K-SDQCR07	S10K-SDQCL07	10	7	125	13	10°	DCMT 0702□□	CS2560	FT-7	0.15	0.15	6005-600	6005-700
S12M-SDQCR07	S12M-SDQCL07	12	9	150	16	8°				0.18	0.18	6005-601	6005-701
S16Q-SDQCR07	S16Q-SDQCL07	16	11	180	20	6°				0.28	0.28	6005-602	6005-702
S20R-SDQCR11	S20R-SDQCL11	20	13	200	25	8°	DCMT 11T3□□	CS4010	FT-15	0.45	0.45	6005-603	6005-703
S25R-SDQCR11	S25R-SDQCL11	25	17	200	32	4°				0.60	0.60	6005-604	6005-704

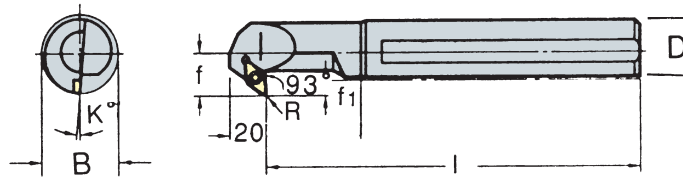

ORDER NO.		DIMENSIONS					INSERT	PARTS		WEIGHT(kg)		CODE NO.	
Righthand	Lefthand	D	F	I	B	K°				Right	Left	Right	Left
S12M-SDZCR07	S12M-SDZCL07	12	10.5	150	14	9°	DCMT 0702□□	CS2560	FT-7	0.18	0.18	6005-630	6005-730
S16Q-SDZCR07	S16Q-SDZCL07	16	12.5	180	16	8°				0.28	0.28	6005-631	6005-731
S20R-SDZCR11	S20R-SDZCL11	20	15.5	200	20	8°	DCMT 11T3□□	CS4010	FT-15	0.45	0.45	6005-632	6005-732
S25R-SDZCR11	S25R-SDZCL11	25	18	200	25	6°				0.60	0.60	6005-633	6005-733

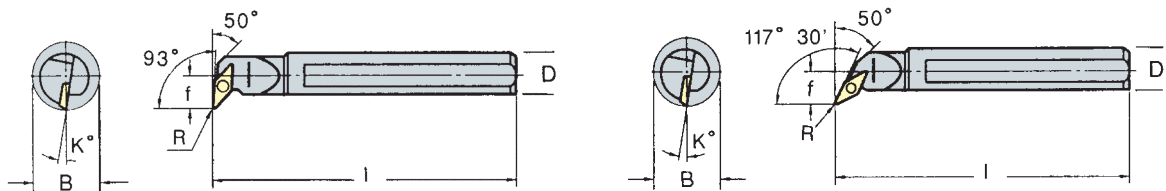

ORDER NO.		DIMENSIONS					INSERT	PARTS		WEIGHT(kg)		CODE NO.	
Righthand	Lefthand	D	F	I	B	K°				Right	Left	Right	Left
S16Q-SVUCR11	S16Q-SVUCL11	16	13	180	22	7°	VBMT 1103□□	CS2560	FT-7	0.28	0.28	6005-660	6005-760
S20R-SVUCR11	S20R-SVUCL11	20	15	200	27	6°				0.45	0.45	6005-661	6005-761
S25R-SVUCR16	S25R-SVUCL16	25	18	200	33	4°	VBMT1604	CS3590	FT-15	0.60	0.60	6005-662	6005-762
S16Q-SVQCR11	S16Q-SVQCL11	16	13	180	22	7°	VBMT 1103□□	CS2560	FT-7	0.28	0.28	6005-690	6005-790
S20R-SVQCR11	S20R-SVQCL11	20	15	200	27	6°				0.45	0.45	6005-691	6005-791
S25R-SVQCR16	S25R-SVQCL16	25	18	200	33	4°	VBMT1604	CS3590	FT-15	0.60	0.60	6005-692	6005-792



Technical Data

Milling & Turning Insert Identification

A	B	C
D	E	F
G	H	I

2 Relief angle

tolerances						
IC: theoretical diameter of the insert inscribed circle T: thickness B: see figure below						
tolerance class	tolerance on "IC"		tolerance on "B"		tolerance on "T"	
	in	mm	in	mm	in	mm
C	±0.010	±0.025	±0.0005	±0.013	±0.001	±0.025
H	±0.005	±0.013	±0.0005	±0.013	±0.001	±0.025
E	±0.010	±0.025	±0.0010	±0.025	±0.001	±0.025
G	±0.010	±0.025	±0.0010	±0.025	±0.005	±0.13
M	see tables at right		see tables at right		±0.005	±0.13
U	see tables at right		see tables at right		±0.005	±0.13

3 tolerance

H	O	P	R	S
T	C	D	E	M
V	L	A	B	K

1 Shape

N		T	
R		Q	
F		U	
A		B	
M		H	
G		C	
W		J	

4 Insert type

inch	C	N	M	G	—	4	3	2			
(metric)	C	N	M	G		12	04	08			
position	1	2	3	4		5	6	7	8	9	10

5 Size										
inch	IC		metric cutting edge length							
	in	mm	C	D	R	S	T	V	W	
1.2 (5)	5/22	3.97	-	04	03	03	06	-	-	-
1.5 (6)	3/16	4.76	04	05	04	04	08	08	-	-
1.8 (7)	7/22	5.56	05	06	05	05	09	09	03	-
-	0.236	6.00	-	-	06	-	-	-	-	-
2	1/4	6.35	06	07	06	06	11	11	04	-
2.5	5/16	7.94	08	09	07	07	13	13	05	-
-	0.315	8.00	-	-	08	-	-	-	-	-
3	3/8	9.52	09	11	09	09	16	16	06	-
-	0.394	10.00	-	-	10	-	-	-	-	-
3.5	1/16	11.11	11	13	11	11	19	19	07	-
-	0.472	12.00	-	-	12	-	-	-	-	-
4	1/2	12.70	12	15	12	12	22	22	08	-
4.5	9/16	14.29	14	17	14	14	24	24	09	-
5	5/8	15.88	16	19	15	15	27	27	10	-
-	0.630	16.00	-	-	16	-	-	-	-	-
5.5	11/16	17.46	17	21	17	17	30	30	11	-
6	3/4	19.05	19	23	19	19	33	33	13	-
-	0.787	20.00	-	-	20	-	-	-	-	-
7	7/8	22.22	22	27	22	22	38	38	15	-
-	0.984	25.00	-	-	25	-	3	-	-	-
8	1	25.40	25	31	25	25	44	44	17	-
10	1-1/4	31.75	32	38	31	31	54	54	21	-
-	1.260	32.00	-	-	32	-	-	-	-	-

6 thickness			
thickness		symbol	
in	mm	inch	metric
1/32	0.79	0.5(1)	-
1/16	1.59	1(2)	01
5/64	1.98	1.2	T1
3/32	2.38	1.5(3)	02
1/8	3.18	2	03
5/22	3.97	2.5	T3
3/16	4.76	3	04
7/32	5.56	3.5	05
1/4	6.35	4	06
5/16	7.94	5	07
3/8	9.52	6	09
7/16	11.11	7	11
1/2	12.70	8	12

NOTE: Inch sizes in parenthesis for "Alternate sizes" D or E (under 1/4 inch IC.)

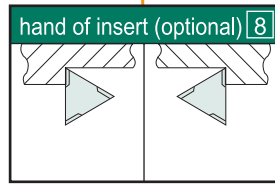

7 corner radius			
corner radius		symbol	
in	mm	inch	metric
.004	0.1	0	01
.008	0.2	0.5	02
1/64	0.4	1	04
1/32	0.8	2	08
3/64	1.2	3	12
1/16	1.6	4	16
5/64	2.0	5	20
3/32	2.4	6	24
7/64	2.8	7	28
1/8	3.2	8	32
round insert (inch)	-	-	00
round insert (metric)	-	-	M0

9 & 10	
cutting edge condition or chip control features (optional)	
T	- negative land
K	- light feed chip control. double sided Kenioc insert
M	- heavy feed chip control. deep floor Kenioc
N	- narrow land Kenloc insert with chip control on one side
W	- heavy-duty chip control. wide land Kenloc insert one side
J	- polished to 4-microinch A4 (rake face only)
UF	- ultra-fine finishing. See Technical Section for additional conditions and chip control features

NOTE: Inch sizes in parenthesis for "alternate sizes" D or E (under 1/4 inch IC.)



Insert For Face Mill Cutter

EXAMPLE

Positive
Axial Rake
Radial Rake

45°

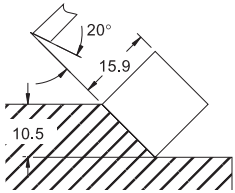

5/8 x 3/16 Insert
SEC 53
SECN 1504
SEKN 1504
FOR SE-545

Positive
Axial Rake
Radial Rake

45°

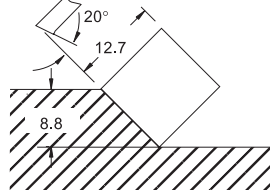

1/2 x 1/8 Insert
SEC 42
SECN 1203
SEKN 1203
FOR SE-445

Positive
Axial Rake
Positive
Radial Rake

65°

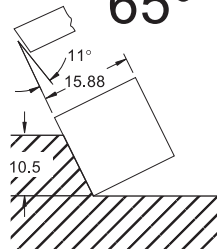

5/8 x 3/16 Insert
SPU-53, SPCN1504
SPG-53, SPKN1504
FOR SP-TYPE

Positive
Axial Rake
Radial Rake

75°

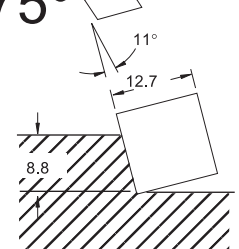

1/2 x 1/8 Insert
SPU-42, SPKN1203
SPG-42, SPMN1203
FOR FP-TYPE

Positive
Axial Rake

90°

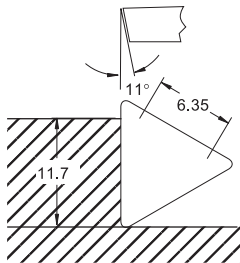

1/4 x 3/32 Insert
TPG-21
TPMN1102
FOR SAE-TYPE

Positive
Axial Rake

90°

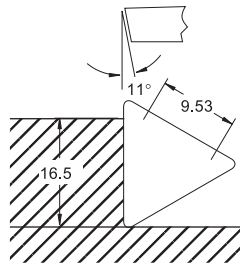

3/8 x 1/8 Insert
TPU-32
TPG-32
TPMN1603
TPCN1603
FOR SAE-TYPE

Positive
Axial Rake
Radial Rake

90°

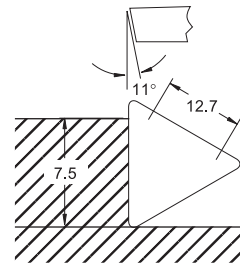

1/2 x 3/16 Insert
TPk-43
TPKN2204
TPMN2204
FOR TP-TYPE





Solid Carbide End Mills For <48HRC

Micro grain 10% Co Grade

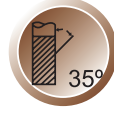

Suit For Materials Groups

GR.1 Non alloyed steels Alloyed steels	GR.2 Heat resistant steels Stainless steels	GR.3 Hardened steels < 48 HRC	GR.4 Hardened steels 48-56 HRC
GR.5 Hardened steels 56-68 HRC	GR.6 Iron	GR.7 Titanium	GR.8 Nickel
GR.9 Copper Brass Bronze	GR.10 Aluminium	GR.11 Synthetic materials	GR.12 Composite materials



Standard Length(Order No.VE122F-Dia)

Unit:mm

Order No.	Dia of Mill Tol e8	Shank Dia mm	Flute Length mm	Overall Length mm	Code No.
VE122-1.0	1.00	4	3	50	6007-020
VE122-1.5	1.50	4	4	50	6007-021
VE122-2.0	2.00	4	6	50	6007-022
VE122-2.5	2.50	4	8	50	6007-023
VE122-3.0	3.00	6	8	50	6007-024
VE122-3.5	3.50	6	10	50	6007-025
VE122-4.0	4.00	6	11	50	6007-026
VE122-4.5	4.50	6	11	50	6007-027
VE122-5.0	5.00	6	13	50	6007-028
VE122-5.5	5.50	6	16	50	6007-029
VE122-6.0	6.00	6	16	50	6007-030
VE122-7.0	7.00	8	20	60	6007-031
VE122-8.0	8.00	8	20	60	6007-032
VE122-9.0	9.00	10	22	72	6007-033
VE122-10.0	10.00	10	25	72	6007-034
VE122-11.0	11.00	12	26	75	6007-035
VE122-12.0	12.00	12	30	75	6007-036
VE122-14.0	14.00	16	32	100	6007-037
VE122-16.0	16.00	16	38	100	6007-038
VE122-18.0	18.00	20	38	100	6007-039
VE122-20.0	20.00	20	38	100	6007-040

Stub Length(Order No.VE112F-Dia)

Unit:mm

Order No.	Dia of Mill Tol e8	Shank Dia mm	Flute Length mm	Overall Length mm	Code No.
VE112-1.0	1.0	3	3.0	38	6007-001
VE112-1.5	1.5	3	4.0	38	6007-002
VE112-2.0	2.0	3	6.0	38	6007-003
VE112-2.5	2.5	3	8.0	38	6007-004
VE112-3.0	3.0	3	8.0	38	6007-005
VE112-3.5	3.5	4	10.0	50	6007-006
VE112-4.0	4.0	4	11.0	50	6007-007
VE112-4.5	4.5	5	13.0	50	6007-008
VE112-5.0	5.0	5	13.0	50	6007-009
VE112-5.5	5.5	6	16.0	50	6007-010
VE112-6.0	6.0	6	16.0	50	6007-011

Long Length(Order No.VE125F-Dia)

Unit:mm

Order No.	Dia of Mill Tol e8	Shank Dia mm	Flute Length mm	Overall Length mm	Code No.
VE125-3	3	4	12	75	6007-050
VE125-4	4	4	15	75	6007-051
VE125-5	5	6	20	75	6007-052
VE125-6	6	6	20	75	6007-053
VE125-7	7	8	25	100	6007-054
VE125-8	8	8	25	100	6007-055
VE125-9	9	10	30	100	6007-056
VE125-10	10	10	30	100	6007-057
VE125-11	11	12	35	110	6007-058
VE125-12	12	12	35	110	6007-059
VE125-14	14	16	40	150	6007-060
VE125-16	16	16	50	150	6007-061
VE125-20	20	20	55	150	6007-062

Extra Long Length(Order No.VE127F-Dia)

Unit:mm

Order No.	Dia of Mill Tol e8	Shank Dia mm	Flute Length mm	Overall Length mm	Code No.
VE127-3	3	6	12	75	6007-070
VE127-4	4	6	15	75	6007-071
VE127-5	5	6	20	100	6007-072
VE127-6	6	6	20	100	6007-073
VE127-8	8	8	25	150	6007-074
VE127-10	10	10	30	150	6007-075
VE127-12	12	12	35	180	6007-076
VE127-16	16	16	50	210	6007-077
VE127-20	20	20	55	210	6007-078



Solid Carbide End Mills For <48HRC

Micro grain 10% Co Grade

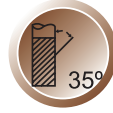

Suit For Materials Groups

GR.1 Non alloyed steels Alloyed steels	GR.2 Heat resistant steels Stainless steels	GR.3 Hardened steels < 48 HRC	GR.4 Hardened steels 48-56 HRC
GR.5 Hardened steels 56-68 HRC	GR.6 Iron	GR.7 Titanium	GR.8 Nickel
GR.9 Copper Brass Bronze	GR.10 Aluminium	GR.11 Synthetic materials	GR.12 Composite materials

Standard Length(Order No.VE124F-Dia)

Unit:mm

Order No.	Dia of Mill Tol e8	Shank Dia mm	Flute Length mm	Overall Length mm	Code No.
VE124-1.00	1.00	4	3	50	6007-100
VE124-1.50	1.50	4	4	50	6007-101
VE124-2.00	2.00	4	6	50	6007-102
VE124-2.50	2.50	4	8	50	6007-103
VE124-3.00	3.00	6	8	50	6007-104
VE124-3.50	3.50	6	10	50	6007-105
VE124-4.00	4.00	6	11	50	6007-106
VE124-4.50	4.50	6	11	50	6007-107
VE124-5.00	5.00	6	13	50	6007-108
VE124-5.50	5.50	6	16	50	6007-109
VE124-6.00	6.00	6	16	50	6007-110
VE124-7.00	7.00	8	20	60	6007-111
VE124-8.00	8.00	8	20	60	6007-112
VE124-9.00	9.00	10	22	72	6007-113
VE124-10.00	10.00	10	25	72	6007-114
VE124-11.00	11.00	12	26	75	6007-115
VE124-12.00	12.00	12	30	75	6007-116
VE124-14.00	14.00	16	32	100	6007-117
VE124-16.00	16.00	16	38	100	6007-118
VE124-18.00	18.00	20	38	100	6007-119
VE124-20.00	20.00	20	38	100	6007-120

Stub Length(Order No.VE114F-Dia)

Unit:mm

Order No.	Dia of Mill Tol e8	Shank Dia mm	Flute Length mm	Overall Length mm	Code No.
VE114-1.00	1.0	3	3.0	38	6007-080
VE114-1.50	1.5	3	4.0	38	6007-081
VE114-2.00	2.0	3	6.0	38	6007-082
VE114-2.50	2.5	3	8.0	38	6007-083
VE114-3.00	3.0	3	8.0	38	6007-084
VE114-3.50	3.5	4	10.0	50	6007-085
VE114-4.00	4.0	4	11.0	50	6007-086
VE114-4.50	4.5	5	11.0	50	6007-087
VE114-5.00	5.0	5	13.0	50	6007-088
VE114-5.50	5.5	6	16.0	50	6007-089
VE114-6.00	6.0	6	16.0	50	6007-090

Long Length(Order No.VE126F-Dia)

Unit:mm

Order No.	Dia of Mill Tol e8	Shank Dia mm	Flute Length mm	Overall Length mm	Code No.
VE126-3	3	4	12	75	6007-130
VE126-4	4	4	15	75	6007-131
VE126-5	5	6	20	75	6007-132
VE126-6	6	6	20	75	6007-133
VE126-7	7	8	25	100	6007-134
VE126-8	8	8	25	100	6007-135
VE126-9	9	10	30	100	6007-136
VE126-10	10	10	30	100	6007-137
VE126-11	11	12	35	110	6007-138
VE126-12	12	12	35	110	6007-139
VE126-14	14	16	40	150	6007-140
VE126-16	16	16	50	150	6007-141
VE126-20	20	20	55	150	6007-142

Extra Long Length(Order No.VE128F-Dia)

Unit:mm

Order No.	Dia of Mill Tol e8	Shank Dia mm	Flute Length mm	Overall Length mm	Code No.
VE128-3	3	6	12	75	6007-150
VE128-4	4	6	15	75	6007-151
VE128-5	5	6	20	100	6007-152
VE128-6	6	6	20	100	6007-153
VE128-8	8	8	25	150	6007-154
VE128-10	10	10	30	150	6007-155
VE128-12	12	12	35	180	6007-156
VE128-16	16	16	50	210	6007-157
VE128-20	20	20	50	210	6007-158



Solid Carbide Ball Nose End Mills For <48HRC

Micro grain 10% Co Grade

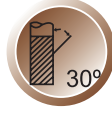

Suit For Materials Groups

GR.1 Non alloyed steels Alloyed steels	GR.2 Heat resistant steels Stainless steels	GR.3 Hardened steels < 48 HRC	GR.4 Hardened steels 48-56 HRC
GR.5 Hardened steels 56-68 HRC	GR.6 Iron	GR.7 Titanium	GR.8 Nickel
GR.9 Copper Bronze	GR.10 Aluminium	GR.11 Synthetic materials	GR.12 Composite materials



Standard Length(Order No.VB222F-Dia)

Unit:mm

Order No.	Dia of Mill Tol e8	Shank Dia mm	Flute Length mm	Overall Length mm	Code No.
VB222-1	1.00x0.50R	4	2	50	6007-180
VB222-1.5	1.50x0.75R	4	3	50	6007-181
VB222-2	2.00x1.00R	4	4	50	6007-182
VB222-2.5	2.50x1.25R	4	5	50	6007-183
VB222-3	3.00x1.50R	6	6	50	6007-184
VB222-3.5	3.50x1.75R	6	7	50	6007-185
VB222-4	4.00x2.00R	6	8	50	6007-186
VB222-4.5	4.50x2.25R	6	9	50	6007-187
VB222-5	5.00x2.50R	6	10	50	6007-188
VB222-5.5	5.50x2.75R	6	11	50	6007-189
VB222-6	6.00x3.00R	6	12	50	6007-190
VB222-7	7.00x3.50R	8	14	60	6007-191
VB222-8	8.00x4.00R	8	16	60	6007-192
VB222-9	9.00x4.50R	10	18	72	6007-193
VB222-10	10.00x5.00R	10	20	72	6007-194
VB222-11	11.00x5.50R	12	22	75	6007-195
VB222-12	12.00x6.00R	12	24	75	6007-196
VB222-14	14.00x7.00R	16	28	100	6007-197
VB222-16	16.00x8.00R	16	32	100	6007-198
VB222-18	18.00x9.00R	20	36	100	6007-199
VB222-20	20.00x10.0R	20	40	100	6007-200

Stub Length(Order No.VB221F-Dia)

Unit:mm

Order No.	Dia of Mill Tol e8	Shank Dia mm	Flute Length mm	Overall Length mm	Code No.
VB221-1	1.0x0.50R	3	2.0	38	6007-160
VB221-1.5	1.5x0.75R	3	3.0	38	6007-161
VB221-2	2.0x1.00R	3	4.0	38	6007-162
VB221-2.5	2.5x1.25R	3	5.0	38	6007-163
VB221-3	3.0x1.50R	3	6.0	38	6007-164
VB221-3.5	3.5x1.75R	4	7.0	50	6007-165
VB221-4	4.0x2.00R	4	8.0	50	6007-166
VB221-4.5	4.5x2.25R	5	9.0	50	6007-167
VB221-5	5.0x2.50R	5	10.0	50	6007-168
VB221-5.5	5.5x2.75R	6	11.0	50	6007-169
VB221-6	6.0x3.00R	6	12.0	50	6007-170

Long Length(Order No.VB232F-Dia)

Unit:mm

Order No.	Dia of Mill Tol e8	Shank Dia mm	Flute Length mm	Overall Length mm	Code No.
VB232-3	3.0x1.50R	4	6	75	6007-210
VB232-4	4.0x2.00R	4	8	75	6007-211
VB232-5	5.0x2.50R	6	10	75	6007-212
VB232-6	6.0x3.00R	6	12	75	6007-213
VB232-7	7.0x3.50R	8	14	100	6007-214
VB232-8	8.0x4.00R	8	16	100	6007-215
VB232-9	9.0x4.50R	10	18	100	6007-216
VB232-10	10.0x5.00R	10	20	100	6007-217
VB232-11	11.0x5.50R	12	22	110	6007-218
VB232-12	12.0x6.00R	12	24	110	6007-219
VB232-14	14.0x7.00R	16	28	150	6007-220
VB232-16	16.0x8.00R	16	32	150	6007-221
VB232-20	20.0x10.00R	20	40	150	6007-222

Extra Long Length(Order No.VB242F-Dia)

Unit:mm

Order No.	Dia of Mill Tol e8	Shank Dia mm	Flute Length mm	Overall Length mm	Code No.
VB242-3	3.0x1.50R	6	9	75	6007-230
VB242-4	4.0x2.00R	6	12	75	6007-231
VB242-5	5.0x2.50R	6	16	100	6007-232
VB242-6	6.0x3.00R	6	20	100	6007-233
VB242-8	8.0x4.00R	8	25	150	6007-234
VB242-10	10.0x5.00R	10	30	150	6007-235
VB242-12	12.0x6.00R	12	35	180	6007-236
VB242-16	16.0x8.00R	16	40	210	6007-237
VB242-20	20.0x10.00R	20	50	210	6007-238



Solid Carbide End Mills For <68HRC

Ultra micro grain 12% Co Grade

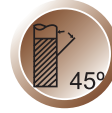

Suit For Materials Groups

GR.1 Non alloyed steels Alloyed steels	GR.2 Heat resistant steels Stainless steels	GR.3 Hardened steels < 48 HRC	GR.4 Hardened steels 48-56 HRC
GR.5 Hardened steels 56-68 HRC	GR.6 Iron	GR.7 Titanium	GR.8 Nickel
GR.9 Copper Brass Bronze	GR.10 Aluminium	GR.11 Synthetic materials	GR.12 Composite materials

Standard Length(Order No.VE166X-Dia) Unit:mm

Order No.	Dia of Mill Tol e8	Shank Dia mm	Flute Length mm	Overall Length mm	Code No.
VE166-3	3	6	8	50	6007-240
VE166-4	4	6	11	50	6007-241
VE166-5	5	6	13	50	6007-242
VE166-6	6	6	16	50	6007-243
VE166-8	8	8	20	60	6007-244
VE166-10	10	10	22	72	6007-245
VE166-12	12	12	26	75	6007-246
VE166-16	16	16	38	100	6007-247
VE166-20	20	20	38	100	6007-248

Long Length(Order No.VE167X-Dia) Unit:mm

Order No.	Dia of Mill Tol e8	Shank Dia mm	Flute Length mm	Overall Length mm	Code No.
VE167-6	6	6	26	70	6007-250
VE167-8	8	8	36	90	6007-251
VE167-10	10	10	46	100	6007-252
VE167-12	12	12	56	110	6007-253
VE167-16	16	16	66	140	6007-254
VE167-20	20	20	76	160	6007-255



Solid Carbide NC/CNC Spot Drills

Micro grain 10% Co Grade

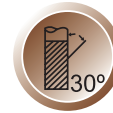

Suit For Materials Groups

GR.1 Non alloyed steels Alloyed steels	GR.2 Heat resistant steels Stainless steels	GR.3 Hardened steels < 48 HRC	GR.4 Hardened steels 48-56 HRC
GR.5 Hardened steels 56-68 HRC	GR.6 Iron	GR.7 Titanium	GR.8 Nickel
GR.9 Copper Brass Bronze	GR.10 Aluminium	GR.11 Synthetic materials	GR.12 Composite materials

Standard Length 90°Angle(Order No.VD903-Dia) Unit:mm

Order No.	Dia of Mill Tol e8	Shank Dia mm	Flute Length mm	Overall Length mm	Code No.
VD903-3	3	3	10	40	6007-260
VD903-4	4	4	12	50	6007-261
VD903-5	5	5	15	50	6007-262
VD903-6	6	6	20	60	6007-263
VD903-8	8	8	25	60	6007-264
VD903-10	10	10	25	76	6007-265
VD903-12	12	12	30	76	6007-266
VD903-16	16	16	35	100	6007-267
VD903-20	20	20	40	100	6007-268

Standard Length 120°Angle(Order No.VD913-Dia) Unit:mm

Order No.	Dia of Mill Tol e8	Shank Dia mm	Flute Length mm	Overall Length mm	Code No.
VD913-3	3	3	10	40	6007-270
VD913-4	4	4	12	50	6007-271
VD913-5	5	5	15	50	6007-272
VD913-6	6	6	20	60	6007-273
VD913-8	8	8	25	60	6007-274
VD913-10	10	10	25	76	6007-275
VD913-12	12	12	30	76	6007-276
VD913-16	16	16	35	100	6007-277
VD913-20	20	20	40	100	6007-278

Long Length 90°Angle(Order No.VD904-Dia) Unit:mm

Order No.	Dia of Mill Tol e8	Shank Dia mm	Flute Length mm	Overall Length mm	Code No.
VD904-6	6	6	20	100	6007-280
VD904-8	8	8	25	125	6007-281
VD904-10	10	10	25	150	6007-282
VD904-12	12	12	30	150	6007-283
VD904-16	16	16	35	150	6007-284
VD904-20	20	20	40	150	6007-285

Long Length 120°Angle(Order No.VD914-Dia) Unit:mm

Order No.	Dia of Mill Tol e8	Shank Dia mm	Flute Length mm	Overall Length mm	Code No.
VD914-6	6	6	20	100	6007-290
VD914-8	8	8	25	125	6007-291
VD914-10	10	10	25	150	6007-292
VD914-12	12	12	30	150	6007-293
VD914-16	16	16	35	150	6007-294
VD914-20	20	20	40	150	6007-295



Finishing End Mills

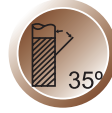
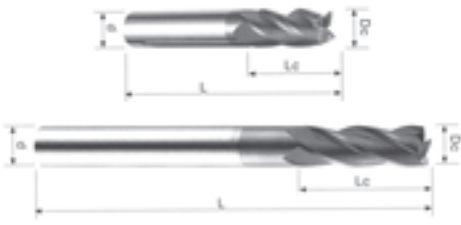

Standard Length(Order No.VE164X-Dc)

Order No.	Dc e8	Lc mm	L mm	d h6	Code No.
VE164-1.0	1.0	3	50	4	6007-300
VE164-1.5	1.5	4	50	4	6007-301
VE164-2.0	2.0	6	50	4	6007-302
VE164-2.5	2.5	8	50	4	6007-303
VE164-3.0	3.0	8	50	6	6007-304
VE164-3.5	3.5	10	50	6	6007-305
VE164-4.0	4.0	11	50	6	6007-306
VE164-4.5	4.5	11	50	6	6007-307
VE164-5.0	5.0	13	50	6	6007-308
VE164-5.5	5.5	16	50	6	6007-309
VE164-6.0	6.0	16	50	6	6007-310
VE164-7.0	7.0	20	60	8	6007-311
VE164-8.0	8.0	20	60	8	6007-312
VE164-9.0	9.0	22	72	10	6007-313
VE164-10.0	10.0	22	72	10	6007-314
VE164-11.0	11.0	26	75	12	6007-315
VE164-12.0	12.0	26	75	12	6007-316
VE164-14.0	14.0	32	100	16	6007-317
VE164-16.0	16.0	38	100	16	6007-318
VE164-18.0	18.0	38	100	20	6007-319
VE164-20.0	20.0	38	100	20	6007-320

Work Material

GR.1 Steels	GR.2 Heat resistant steels Stainless steels	GR.3 < 48 HRC	GR.4 48-56 HRC
GR.5 Hardened steels 56-68 HRC	GR.6 Iron	GR.7 Titanium	GR.8 Nickel
GR.9 Copper Brass Bronze	GR.10 Aluminium	GR.11 Synthetic materials	GR.12 Composite materials

Long Length(Order No.VE165X-Dc)

Order No.	Dc e8	Lc mm	L mm	d h6	Code No.
VE165-3	3	12	70	6	6007-330
VE165-4	4	15	70	6	6007-331
VE165-5	5	20	80	6	6007-332
VE165-6	6	20	80	6	6007-333
VE165-7	7	25	90	8	6007-334
VE165-8	8	25	90	8	6007-335
VE165-9	9	30	100	10	6007-336
VE165-10	10	30	100	10	6007-337
VE165-11	11	35	110	12	6007-338
VE165-12	12	35	110	12	6007-339
VE165-14	14	40	120	16	6007-340
VE165-16	16	50	140	16	6007-341
VE165-20	20	55	160	20	6007-342



Ball Nose End Mills

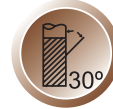

Standard Length(Order No.VB262X-Dc)

Order No.	Dc e8	R ±0.01	Lc mm	L mm	d h6	Code No.
VB262-1.0	1.0	0.50R	2.5	50	4	6007-350
VB262-1.5	1.5	0.75R	4.0	50	4	6007-351
VB262-2.0	2.0	1.00R	5.0	50	4	6007-352
VB262-2.5	2.5	1.25R	6.0	50	4	6007-353
VB262-3.0	3.0	1.50R	6.0	50	6	6007-354
VB262-4.0	4.0	2.00R	8.0	50	6	6007-355
VB262-5.0	5.0	2.50R	12.0	50	6	6007-356
VB262-6.0	6.0	3.00R	12.0	50	6	6007-357
VB262-7.0	7.0	3.50R	14.0	60	8	6007-358
VB262-8.0	8.0	4.00R	14.0	60	8	6007-359
VB262-9.0	9.0	4.50R	18.0	72	10	6007-360
VB262-10.0	10.0	5.00R	18.0	72	10	6007-361
VB262-12.0	12.0	6.00R	22.0	75	12	6007-362
VB262-14.0	14.0	7.00R	26.0	100	16	6007-363
VB262-16.0	16.0	8.00R	30.0	100	16	6007-364
VB262-20.0	20.0	10.00R	38.0	100	20	6007-365

Work Material

GR.1 Steels	GR.2 Heat resistant steels Stainless steels	GR.3 < 48 HRC	GR.4 48-56 HRC
GR.5 Hardened steels 56-68 HRC	GR.6 Iron	GR.7 Titanium	GR.8 Nickel
GR.9 Copper Brass Bronze	GR.10 Aluminium	GR.11 Synthetic materials	GR.12 Composite materials

Long Length(Order No.VB263X-Dc)

Order No.	Dc e8	R 0.01	Lc mm	L mm	d h6	Code No.
VB263-2A	2A	1.0R	5	60	3	6007-370
VB263-3A	3A	1.5R	6	70	3	6007-371
VB263-4A	4A	2.0R	8	70	4	6007-372
VB263-2	2	10.R	5	60	6	6007-373
VB263-3	3	1.5R	6	70	6	6007-374
VB263-4	4	2.0R	8	70	6	6007-375
VB263-5	5	2.5R	12	80	6	6007-376
VB263-6	6	3.0R	12	80	6	6007-377
VB263-7	7	3.5R	14	90	8	6007-378
VB263-8	8	4.0R	14	90	8	6007-379
VB263-9	9	4.5R	18	100	10	6007-380
VB263-10	10	5.0R	18	100	10	6007-381
VB263-12	12	6.0R	22	110	12	6007-382
VB263-14	14	7.0R	26	120	16	6007-383
VB263-16	16	8.0R	30	140	16	6007-384
VB263-20	20	10.0R	38	160	20	6007-385



Machine Reamers In Steps of 0.5mm



Straight Shank(Order No.VR301-Dc)

Order No.	Dc H7	Lc mm	L mm	d mm	Z teeth	Code No.
VR301-2.0	2.0	11	49	2.0	4	6007-390
VR301-2.5	2.5	14	57	2.5	4	6007-391
VR301-3.0	3.0	15	61	3.0	4	6007-392
VR301-3.5	3.5	18	70	3.5	4	6007-393
VR301-4.0	4.0	19	75	4.0	4	6007-394
VR301-4.5	4.5	21	80	4.5	4	6007-395
VR301-5.0	5.0	23	86	5.0	6	6007-396
VR301-5.5	5.5	26	93	5.5	6	6007-397
VR301-6.0	6.0	26	93	6.0	6	6007-398
VR301-6.5	6.5	28	101	6.5	6	6007-399
VR301-7.0	7.0	31	109	7.0	6	6007-400
VR301-7.5	7.5	31	109	7.5	6	6007-401
VR301-8.0	8.0	33	117	8.0	6	6007-402
VR301-8.5	8.5	33	117	8.5	6	6007-403
VR301-9.0	9.0	36	125	9.0	6	6007-404
VR301-9.5	9.5	36	125	9.5	6	6007-405
VR301-10.0	10.0	38	133	10.0	6	6007-406
VR301-10.5	10.5	38	133	10.0	6	6007-407



Work Material

GR.1 Steels	GR.2 Heat resistant steels Stainless steels	GR.3 < 48 HRC	GR.4 48-56 HRC
GR.5 Hardened steels 56-68 HRC	GR.6 Iron	GR.7 Titanium	GR.8 Nickel
GR.9 Copper	GR.10 Aluminium	GR.11 Synthetic materials	GR.12 Composite materials

※ 2.0-9.5 VHM Solid Carbide ※ 10.0-20.0 HM Carbide Tipped

Order No.	Dc H7	Lc mm	L mm	d mm	Z teeth	Code No.
VR301-11.0	11.0	41	142	10.0	6	6007-408
VR301-11.5	11.5	41	142	10.0	6	6007-409
VR301-12.0	12.0	44	151	10.0	6	6007-410
VR301-12.5	12.5	44	151	10.0	6	6007-411
VR301-13.0	13.0	44	151	10.0	6	6007-412
VR301-13.5	13.5	47	160	12.5	6	6007-413
VR301-14.0	14.0	47	160	12.5	6	6007-414
VR301-14.5	14.5	50	162	12.5	6	6007-415
VR301-15.0	15.0	50	162	12.5	6	6007-416
VR301-15.5	15.5	52	170	12.5	6	6007-417
VR301-16.0	16.0	52	170	12.5	6	6007-418
VR301-17.0	17.0	54	175	14.0	6	6007-419
VR301-18.0	18.0	56	182	14.0	6	6007-420
VR301-19.0	19.0	58	189	16.0	6	6007-421
VR301-20.0	20.0	60	195	16.0	6	6007-422



Machine Reamers Carbida Tipped



Taper Shank(Order No.VR303-Dc)

Unit:mm

Order No.	Dc H7	Lc mm	L mm	d mm	Z teeth	Code No.
VR303-10.0	10.0	38	168	1	6	6007-430
VR303-11.0	11.0	41	175	1	6	6007-431
VR303-12.0	12.0	44	182	1	6	6007-432
VR303-13.0	13.0	44	182	1	6	6007-433
VR303-14.0	14.0	47	189	1	6	6007-434
VR303-15.0	15.0	50	204	2	6	6007-435
VR303-16.0	16.0	52	210	2	6	6007-436
VR303-17.0	17.0	54	214	2	6	6007-437
VR303-18.0	18.0	56	219	2	6	6007-438
VR303-19.0	19.0	58	223	2	6	6007-439
VR303-20.0	20.0	60	228	2	6	6007-440
VR303-22.0	22.0	64	237	2	6	6007-441
VR303-24.0	24.0	68	268	3	8	6007-442



Work Material

GR.1 Steels	GR.2 Heat resistant steels Stainless steels	GR.3 < 48 HRC	GR.4 48-56 HRC
GR.5 Hardened steels 56-68 HRC	GR.6 Iron	GR.7 Titanium	GR.8 Nickel
GR.9 Copper	GR.10 Aluminium	GR.11 Synthetic materials	GR.12 Composite materials

Order No.	Dc H7	Lc mm	L mm	d mm	Z teeth	Code No.
VR303-25.0	25.0	68	268	3	8	6007-443
VR303-26.0	26.0	70	273	3	8	6007-444
VR303-28.0	28.0	71	277	3	8	6007-445
VR303-30.0	30.0	73	281	3	8	6007-446
VR303-32.0	32.0	77	317	4	8	6007-447
VR303-35.0	35.0	78	321	4	8	6007-448
VR303-36.0	36.0	79	325	4	8	6007-449
VR303-38.0	38.0	81	329	4	8	6007-450
VR303-40.0	40.0	81	329	4	8	6007-451